



*Setting Up a New  
Ensite Pro System:  
Hardware and Software*

April 2005 Revision • Item # H-PRONEW

## Contents

<b>Chapter 1: Setting Up Your System .....</b>	<b>3</b>
<b>Warning: Dedicated Procedures .....</b>	<b>3</b>
<b>Setting Up Your System: An Overview .....</b>	<b>4</b>
<b>Integrating Your DDMS Server Into Your Existing Network .....</b>	<b>5</b>
Existing Network Settings: Example One .....	5
Existing Network Settings: Example Two .....	7
<b>Setting Up Users .....</b>	<b>12</b>
Changing Volume Serials .....	13
<b>Setting Up Workstations for Text-Based Applications .....</b>	<b>16</b>
Installing Ensite Pro Graphical Client on a Workstation .....	17
Setting Up Peripherals .....	18
Setting Up Dumb Terminals .....	21
<b>Chapter 2: Maintaining Your Ensite Pro System .....</b>	<b>24</b>
<b>Preparing for Day-End .....</b>	<b>24</b>
Stopping (Killing) a Process .....	25
Backing Up DDMS Files .....	25
Restoring Files From Tape .....	26
Shutting Down the System .....	29
<b>Appendix: Dedicated Functions .....</b>	<b>30</b>
<b>Performing a Dedicated Function .....</b>	<b>30</b>
<b>Dedicated Functions .....</b>	<b>31</b>
Functions Using Windows Software .....	31
Period Ending Procedures .....	31
Parameters Screens .....	31
Releasing Batches .....	32
Special Screen Functions, if modifying data .....	32
Utilities (functions in the (Z) screen) .....	32

# Chapter 1: Setting Up Your System

This chapter explains how to set up your Ensite Pro system. You may have purchased your Ensite Pro system in one of two ways:

- **System with hardware and software:** You purchased both the DDMS software and your hardware from DDMS. (In this case, hardware specifically means the server that will run Ensite Pro software.)
- **System with software only:** You purchased only the software from DDMS, supplying your own hardware.

This document explains how to set up systems where both hardware and software were purchased from DDMS.

If you purchased software only, please request **Setting Up a New Ensite Pro System: Software Only**.

## Warning: Dedicated Procedures

A number of procedures are dedicated on Ensite Pro systems. This means that they can only be done when no one else is using the system.

*Performing a dedicated function while other people are using the system can cause loss of information and corruption of files.*

Review the list of dedicated procedures in **Appendix: Dedicated Functions**, and make sure no one uses the system while you're performing any of these.

---

**ATTENTION!** Any updates to Ensite Pro must be done from a CD-ROM or diskette. If you receive a tape instead of a CD-ROM or diskette, contact DDMS at 800-366-4778 before continuing.

---

## Setting Up Your System: An Overview

The steps below give you an overview of the basic steps you'll take to set up your Ensite Pro system. These steps are described in detail later in this chapter.

- 1 Integrate your Ensite Pro Server into your Windows 2000 network.

For details, see the heading **Integrating Your Ensite Pro Server into Your Existing Network**.

---

**Note:** If you do not use your Ensite Pro server on a network, skip this step and go to **Step 2**.

---

- 2 Set up your users. See the heading **Setting Up Users**.

- 3 Create volumes to hold system information. See **Changing Volume Serials**.

- 4 Set up your peripherals.

If you're using a network, see **Setting Up Workstations for Text-Based Applications** and **Installing Ensite Pro Graphical Client on a Workstation**. Then follow the instructions under **Setting Up Peripherals**.

If you're using dumb terminals instead of a network, follow the instructions under **Setting Up Peripherals**.

- 5 Check each computer workstation, dumb terminal, and printer. To do this, try logging on to each workstation and terminal, and try printing to each printer.

## Integrating Your DDMS Server Into Your Existing Network

---

*If you do not use the DDMS server on an existing network, you can skip these steps, and go to **Setting Up Users**.*

---

Integrating the DDMS server into your existing network is a variable process and requires a basic knowledge of network systems. Just as your business varies from other dealers, your network system is also unique. For this reason, it can be difficult to address each dealer's existing networking system.

To help you set up your network with the DDMS server, we've included two examples. These examples have been designed to provide setup procedures for some of the most typical networking situations we've encountered. However, they weren't designed to cover each case — individual procedures for setting up existing networks may vary.

By providing basic guidelines, these examples can help a network consultant modify your network to meet DDMS server specifications. Since this section assumes a basic knowledge of configuring network systems, thorough instructions are not included for each step. Instead, use the following text as a guide to help lead you through the process.

### Existing Network Settings: Example One

If your existing network is configured as follows:

Network Type: Peer-to-Peer  
Computers: Windows 98SE, 2000, or Me  
Protocol: TCP/IP

If your existing network does not use the above configuration, see the configuration settings under the heading **Existing Network Settings: Example Two**.

You can use the following checklist to help you set up your DDMS Windows 2000 server with your existing network.

1. **Implement TCP/IP as the First Protocol for Your Existing Network.**  
You can do this in two ways:
  - As an additional protocol (you'll have to temporarily delete the other protocols, add TCP/IP so it's first, and then reload the other protocols)
  - As a replacement for your existing protocol.

**You *must* use a valid, static IP address for your server.**

## Setting Up a New Ensite Pro System

2. **Check the Server Configuration.** Be sure that the Ensite Pro server is configured as a *Stand-Alone Server* or as a *Member Server*.
  - *Do not configure the server as a Domain Controller.*
  - *Do not install third-party software on the server without expressed written consent from DDMS. This includes the BackOffice Suite of Products such as SQL Server, SNA Server, Exchange Server, and so forth.*
3. **Check Network Printer Attachment.** Your network printers should be attached to a dedicated print server device or be attached to a network computer and be shared on the network.
4. **Install the Printer Drivers.** Install printer drivers in Windows 2000 for each printer you'll be using with the DDMS system.
5. **Add the Printer For Use With DDMS.** After your printer is properly installed on the DDMS server and you have successfully printed a test page, you can add the printer and assign it a unique logical printer name, P1, for example. Detailed instructions for adding printers on DDMS are included in this handout. See the heading **Setting Up Printers**.
6. **Print a Test Document.** After you have set up the printer for use with DDMS, restart the TBL Server. Then print a test document to be sure the printer is correctly configured.
7. **Set Up Telnet Client Software.** Telnet Client software allows users to telnet in to DDMS software from PCs on the network. While you can use any Telnet Client software package, Windows systems come equipped with a basic version of Telnet Client software. This software does not include many of the options available through third-party software programs such as Procomm Plus, Reflections, and so forth. However, if the basic Telnet Client package meets your needs, you can set it up without purchasing a third-party software package.
  - If you want to use the Telnet Client software that came with Windows, you can install it using the instructions in the heading **Setting Up Computer Workstations**.
  - If you decide to use a third-party Telnet Client software package, contact the software's vendor for instructions on configuring it correctly. In order to complete the setup, you will need to provide the IP address of the server. You may also be required to provide the server's name.

## Existing Network Settings: Example Two

If your existing network is as follows:

Network Type:	Windows 2000 Single or Multiple Master Domain Model
Computers:	Windows 98SE, 2000, or Me
Protocol:	TCP/IP

Use the following checklist to help you set up your DDMS-NT server with your existing network.

- 1. **Implement TCP/IP as the First Protocol for Your Existing Network.**  
You can do this in two ways:
  - As an additional protocol (you'll have to temporarily delete the other protocols, add TCP/IP so it's first, and then reload the other protocols)
  - As a replacement for your existing protocol.

**You *must* use a valid, static IP address for your server.**

You can use a DHCP Server to facilitate IP leases for your computer workstations on your network. However, *do not* use the DDMS Server as a DHCP Server.
- 2. **Check the Server Configuration.** Be sure that the Ensite Pro server is configured as a *Stand-Alone Server* or as a *Member Server*.
  - *Do not* configure the server as a *Domain Controller*.
  - *Do not* install third-party software on the server without express written consent from DDMS. This includes the BackOffice Suite of Products such as SQL Server, SNA Server, Exchange Server, and so forth.
- 3. **Check Network Printer Attachment.** Your network printer should be attached to a dedicated print server device or be attached to a network computer and be shared on the network.
- 4. **Install the Print Drivers.** Install printer drivers in Windows 2000 for each printer you'll be using with the DDMS system.
- 5. **Add the Printer For Use With DDMS.** After your printer is properly installed on the Ensite Pro server and you have successfully printed a test page, you can add the printer and assign it a unique logical printer name, P1, for example. Detailed instructions for adding printers are included in this handout. See the heading **Setting Up Printers**.

## Setting Up a New Ensite Pro System

- 6. **Print a Test Document.** After you have set up the printer for use with DDMS, restart the TBL Server. Then print a test document to be sure the printer is correctly configured.
- 7. **Set Up Telnet Client Software.** Telnet Client software allows users to telnet in to DDMS software from PCs on the network. This software does not include many of the options available through third-party software programs such as Procomm Plus, Reflections, and so forth. However, if the basic Telnet Client package meets your needs, you can set it up without purchasing a third-party software package.
  - If you want to use the Telnet Client software that came with Windows, you can install it using the instructions in the heading **Setting Up Computer Workstations**.
  - If you decide to use a third-party Telnet Client software package, contact the software's vendor for instructions on configuring it correctly. In order to complete the setup, you will need to provide the IP address of the server. You may also be required to provide the server's name.
- 8. **Log the DDMS server into the Domain.** If you want to use network devices, including printers, you must log the DDMS server into the domain.
- 9. **Check Your Group Settings.** Finally, check to be sure that the Domain Admin Global Group is a member of the DDMS Group. Also check to be sure that it is a member of the local Administrators Group.

## How You Log onto Your PC Matters Now

Even if your network worked well with text-based DDMS software, it may need to be modified for Ensight Pro, since the graphical software interacts more with the network. The text-based software used Telnet to run applications from a PC. The PC's user ID did not matter, because Telnet programs do not check this.

Ensight Pro works with Microsoft Transaction Server, though, which checks the network user name and password, to see if a particular user has permission to access this software.

When you boot a PC that's properly set up on a network, you should see a log-in window like this:

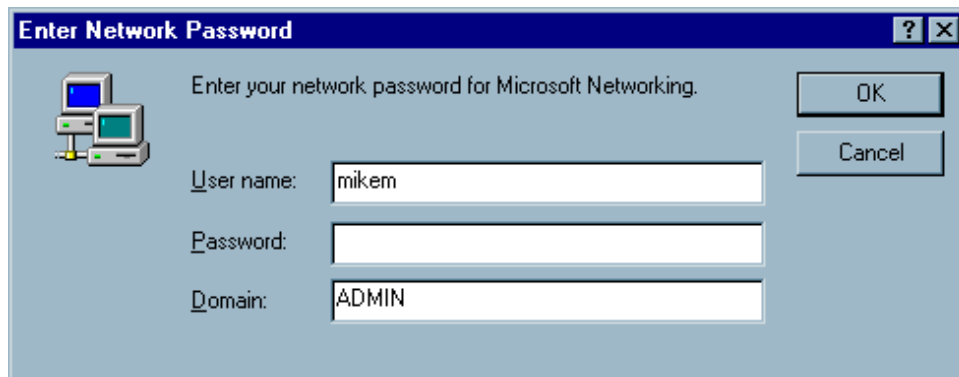

Notice that this window is titled **Enter Network Password**, and it includes a **network icon** (two computers linked together). The last field in this window, Domain, will only appear if you have domains set up on your network. (Domains are optional; you do not need to set them up in order to use Ensight Pro.)

There is another log-in window that may appear instead, which does **not** include the word network, and does not have the network icon. If this alternate window appears, your PC has not been properly configured for your network.

If the Enter Network Password window does appear, you must specify a user name and password that are set up for normal user rights.

---

**Note:** The network will not check your user name and password when you log on, unless you have domains set up. If you click **Cancel** instead of entering a password, for example, your PC will function normally — you'll even be able to see network drives and printers. However, you will not be able to use network features, such as Ensight Pro.

---

## Setting Up a New Ensite Pro System

Your user name must **not** contain spaces; the Ataman TCP Remote Logon Services software cannot work correctly if you have a space in your user name.

### A Simple Test

To see if your user name and password are correctly set up on your network, do the following:

- 1 Go to your DDMS server, and click Start.
- 2 Click Programs, select Accessories, then click Windows Explorer.
- 3 Navigate to your (C:) drive. If necessary, click the plus sign (+) to the left of the (C:) icon, so that you can see the folders it contains.
- 4 Right-click a folder, and select Sharing ... from the menu.
- 5 Click the Shared this folder radio button.
- 6 Click OK.
- 7 Now go to your PC, and start Windows Explorer.
- 8 Attempt to open the shared folder on the server by double-clicking it.

If you can view the contents of the folder, your PC is correctly set up to use network resources, and you'll be able to use Ensite Pro.

If you see a window that prompts for a password to \\servername\IPC\$ (where *servername* is the name of your Ensite Pro server), then you do not have permission to access that server. You will not be able to access Ensite Pro from your PC until this issue is resolved.

- 9 If you're properly set up to use network resources, this procedure is complete.

If you're not properly set up to use network resources, your network administrator should check the following:

#### **If your network has a primary domain controller:**

- Make the Ensite Pro server a member server in the primary domain.
- Log the Ensite Pro server into the primary domain using a domain admin account.
- Set up each person who will use Ensite Pro as a user with a domain account. Remember that users names cannot have spaces.
  - Make sure that users log on to their client machines using these domain accounts.

### **If your network does not have a primary domain controller:**

- Remember that this kind of network does not validate the log-in name and password that a user enters. An improper log-in will not give the user access to the server.
- Check to see whether the user misspelled his or her user name or password when logging in.
- Make sure that the user's PC has Client for Microsoft Networks installed, and that it is installed correctly.
- If the user does not have a valid user account with normal user rights, set up an account. Have the user log off, and then log on using the new name and account. Remember that users names cannot have spaces.
- See if the user mistook the Windows log-on for the network log-on. If a computer has two different user names and passwords set up, one for Windows and one for the network, you'll see two log-on prompts when the machine boots. The name and password that are set up on the server must be entered in the Enter Network Password dialog box.

## Setting Up Users

When you set up DDMS users, the system adds them to the Power Users group, the DDMS Users Group, and Ataman Telnet Servers Group (the software the system uses to allow users to telnet in from PCs on the network.) To create a user:

- 1 From your desktop, double-click the **TBL Configuration** icon. The TBLConfig window appears. This window displays your system settings.
- 2 Right-click **User Definitions** and select **Add New**. The system displays the User Definitions dialog box, shown below.

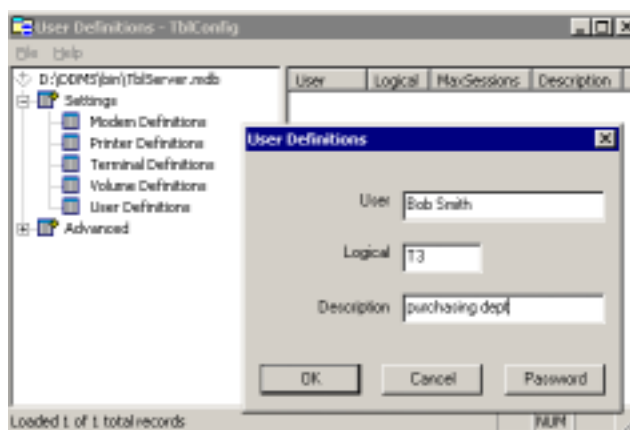

---

*If you want to delete users, right-click the user's name and choose **Delete**.*

---

- 3 Create an entry for each user, following these steps:
  - In the User box, enter the name of the user you are adding. After you enter the name, press Tab.
  - In the Logical box, assign a logical name for this user's terminal. The system uses logical names to identify terminals. These names let you customize a terminal, specifying default printers and locations, for example, and specifying default order entry settings.

Logical names for terminal begin with the letter T, and are followed by a single numeral: TØ, T1, T2, T3, and so forth. Many users can share the same logical name for their terminals.

Enter the number you want to assign this user: highlight the displayed numeral, and type the correct one. If it displays TØ, for example, and you need to specify T3, highlight the Ø and type 3.

You set up logical names for terminals through the (L1) Terminal and Tickets Parameters screen. Until you set them up, you can assign all of your users the logical name TØ, which we set up when we built your system.

- In the Description box, you can enter a description for reference purposes. (Descriptions are optional.) For example, you can specify the user's department or title. After you enter the description, click **OK**.
- The Change Password dialog box appears. At New Password, enter the password you want to assign this user, and press Tab. You can enter up to 31 alphanumeric characters. (This field is case-sensitive. The user must enter the password exactly as it is specified in this field to log on to the system.)

---

**Note:** User passwords are optional. If you do not want to assign them, leave the password boxes blank.

---

- In the Confirm Password box, re-enter the password you specified, and click **OK**.
- When the User Definitions dialog box reappears, click **OK**.
- Repeat this process for each additional user you need to set up.

## Changing Volume Serials

We call folders that contain DDMS files *units*. Each unit has both a number and a name. For example, your DDMS program files are on unit 4. Unit 4's name is SR (which stands for system residence). A unit's name is called its *volume serial*. Using the same example, we say that unit 4 has a volume serial of SR.

You use volume serials to specify where your system stores certain kinds of information. For example, volume serial IN may hold your inventory files, and volume serial HI may hold your history files. You specify the volume serial for each group of files through the DDMS (LØ) Global Master Parameters screen.

***DDMS recommends that you leave your volume serials in their default state when you first begin using your system.*** However, if you change the volumes in your (LØ) Global Master Parameters screen for any reason, you need to modify the volume serials on your DDMS server to match.

## Setting Up a New Ensite Pro System

You can view your volume serials in the TBL Configuration window. If necessary, you can also add new volumes. Use the following instructions to view, modify, and add volume serials:

- 1 From your desktop, double-click TBL Configuration.
- 2 Under the Settings folder, click Volume Definitions. The system displays all volumes that are currently set up on the right hand portion of the window.

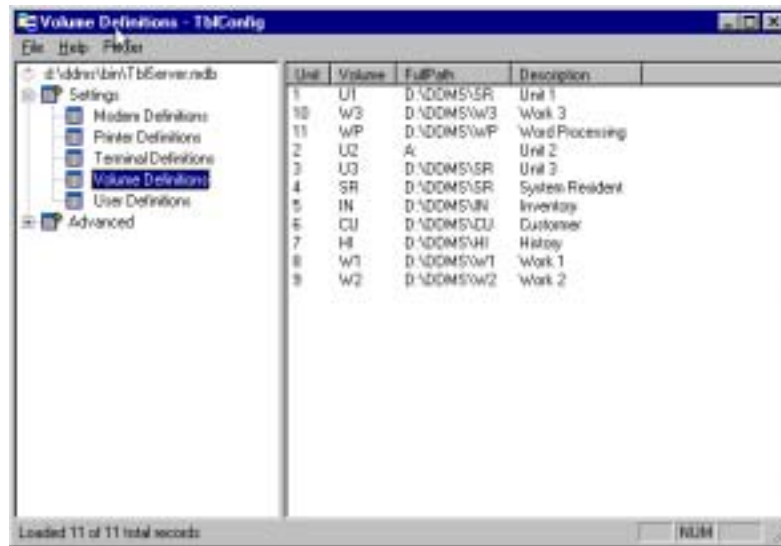

*The Advanced folder in the TblConfig window contains additional information about your system. Do not modify these settings without consulting DDMS.*

- The Unit column displays the DDMS unit number.
  - The Volume column displays the corresponding volume serial.
  - The Full Path column displays where this information is stored on your hard drive.
  - The Description column displays the information that the unit contains.
- 3 View the displayed volume serials to determine which ones you need to add or modify.
    - To modify existing volumes, right-click the number of the unit you want to change, and select Modify. (You cannot modify the Unit or Volume boxes; these boxes can only be set when you add new volumes.)
    - To add a new volume, right-click Volume Definitions and select Add New.

---

**Note:** Never modify a volume that begins with the letter U: U1, U2, U3, and so forth.

---

- 4 The Volume Definition window appears, as shown below. If you are modifying an existing volume, go to **Step 6**.

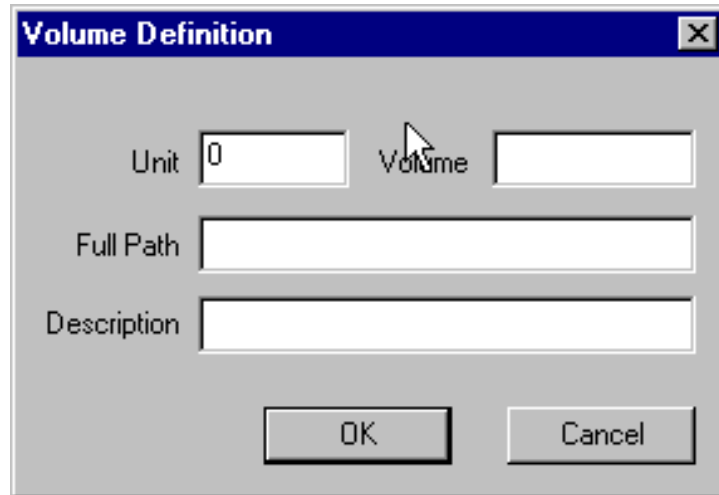

- 5 When you add volumes, you must assign them a unique unit number. In the Unit box, enter the number of the unit you are adding and press Tab.
- 6 In the Volume box, assign this unit a volume serial. *You must use upper-case characters only.* The system uses volume serials to determine where to create groups of files. Volume serials usually have two characters, such as W1, HI, or IN, but you can use up to four characters.
- 7 In the Full Path box, enter the path and folder name for this volume. For example, if your DDMS software is installed on your D: drive, and you are creating a W4 volume serial, you would specify D:\DDMS\W4. Enter the path for this volume serial, and press Tab.
- 8 In the Description box, enter a description for reference purposes. For example, if you are creating a work unit, you could enter Work Unit. After you enter the description, click OK.
- 9 The system adds the new volume serial to the list. You can continue to add or modify as many volumes as necessary.

## Setting Up Workstations for Text-Based Applications

Your DDMS system has both text-based and graphical applications. Users can use either version, since both write information to the same files. At this writing, some applications exist only as text-based applications. Although your system will eventually have a complete set of graphical applications, most users will also want access to the text-based applications until all of them have graphical counterparts.

If you're using a network, be sure that your computer workstations are set up for use with your DDMS server. First be sure that all of your workstations are set according to the following:

- Each workstation must be in an Ethernet network.
- Each workstation must be configured using the TCP/IP set of protocols.
- Each workstation must be running Windows 98SE, 2000, or Me.

Once you verify that all of your workstations meet these guidelines, your next step is to set up the Telnet client software for use with the DDMS system. While you can purchase a third-party Telnet client software package, Windows operating systems come equipped with a Telnet client that you can use.

---

**Note:** If you decide to use a third-party Telnet client software package, contact the software's vendor for instructions on configuring it correctly. In order to complete the setup, you will need to provide the IP address of the server. You may also be required to provide the server's name.

---

To start a Telnet session on a workstation, follow these steps:

- 1 Click the Start button and select Run.
- 2 In the Command line box, type telnet followed by the IP address or host name of the server. If your DDMS servers' IP address is 192.168.100.1, for example, you type telnet 192.168.100.1.
- 3 Click OK.
- 4 When the system displays a window requesting your account name and password, enter your account name and password. You need to specify a user name and password that have been set up through the TBL Configuration program. For details, see the heading **Setting Up Users** earlier in this document.
- 5 After you enter your account name and password, the system displays the DDMS Master Menu.

---

*These steps are for Windows 98. Other Windows operating systems are very similar, although the names of the boxes may differ.*

---

If you plan to use the Telnet client software on the workstation frequently, you can create a desktop icon. Follow these steps:

- 1 Right-click on an open part of the workstation's desktop, click New, and select Shortcut.
- 2 In the Type the Location of the Item box, type **telnet**, followed by the IP address or host name of the server . You might type telnet 192.168.100.1, for example.
- 3 Click Next.
- 4 When the Select A Title For The Program dialog box appears, enter a name for the desktop shortcut icon, DDMS System, for example.
- 5 Click Finish.
- 6 The system displays the desktop icon you created for the Telnet client. Double-click the desktop icon to test it.
- 7 The system prompts you to enter your account name and password. After you enter the information, the system displays the DDMS Master Menu.

### Installing Ensite Pro Graphical Client on a Workstation

You can install Ensite Pro Graphical Client on your Windows 98SE, 2000, or Me workstation. You must also install Microsoft Internet Explorer 4.01 or greater on the workstation. (Windows 98SE, 2000 and Me will automatically have a new enough version of Microsoft Internet Explorer.)

---

**Note:** You must do this when you load Ensite Pro for the first time. When you update the server with subsequent versions, the system should automatically update the workstations. However, if this fails to happen for any reason (because there are several versions released between the software you have and the new one you're loading, for example), you can use the procedure below again.

---

Follow these steps to install the Ensite Pro graphical client:

- 1 Shut down all applications that you may have running, including any anti-virus software or other applications that are part of your start-up.
- 2 Insert the Ensite Pro Interface CD into the CD-ROM drive on your workstation.
- 3 Open Windows Explorer and click the CD-ROM drive.
- 4 Double-click the **ensitepro/client** folder to open it.
- 5 Double-click the Disk 1 folder to open it.
- 6 Double-click Setup.exe.

## Setting Up a New Ensite Pro System

- 7 The Graphical Client window appears. Click Next to continue.
- 8 Follow the prompts on your screen. DDMS recommends that you accept the defaults. When finished, you must reboot your system.
- 9 When the system reboots, open the *Ensite Pro* program by double-clicking Graphical Interface Client on your desktop.
- 10 At Enter the Name of Your MTS Server, enter the name of your DDMS server or its IP address and click OK.

---

**Note:** If you don't know the name of your DDMS server, go to the server, click Start, point to Settings, and select Network and Dial-Up Connections.

Right-click the network connection you use, and select Properties. Click Internet Protocol (TCP/IP) and then click the Properties button. The General tab displays the IP address.

---

## Setting Up Peripherals

As you use your system, you will need to add peripherals such as modems, printers, and terminals. You add, change, and view peripherals using your TBL Configuration software.

### Setting Up Modems

Modems that you use on your DDMS system must **only** be set up through DDMS software. Do **not** set these modems up through the Add/Remove Hardware software in the Control Panel

To set up a modem for use with DDMS:

- 1 From your DDMS server's desktop, double-click TBL Configuration.
- 2 When the TblConfig window appears, right-click Modem Definitions, and select Add New. The Modem Definition dialog box appears, as shown here.

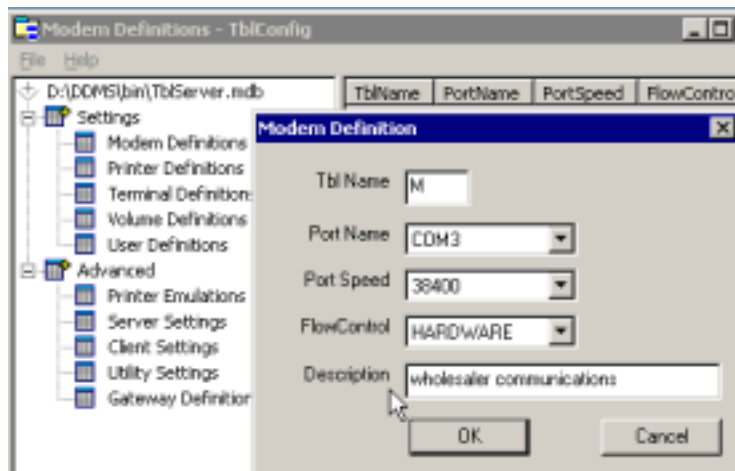

- 4 In the Tbl Name box, click the cursor behind the letter **M** and specify the second character of the modem's logical name. If this is your primary wholesaler communications modem, for example, its logical name is M1, so you would type 1 after the M.
- 5 In the Port Name box, select the COM port you assigned this modem. Remember that COM ports correspond to the ports on your Specialix I/O pad: port 1 is COM 3, port 2 is COM 4, and so forth.
- 6 In the Port Speed box, select the appropriate speed.
- 7 In the Flow Control box, select Hardware.
- 8 In the Description field, you can enter any text for your own reference that describes this modem. For example, you could enter Wholesaler Communications Modem.
- 9 Click OK. The system adds the modem and displays the information you specified.

### Setting Up Printers

Setting up a printer involves three basic steps:

- Connecting the printer to your network.
- Setting up the printer through Windows 2000.
- Configuring your printer for Ensite Pro.

### Connecting your Printer to the Network

To use a printer on your system, you need network access. You can connect a printer to a PC and then share the printer, or you can connect your printer to a network print server. Make sure that you know the network name assigned to this printer.

---

**Note:** DDMS does not recommend the use of serial-interface printers with Ensite Pro. While some customers have used serial interface printers successfully, many have experienced reliability problems. DDMS does not support the use of serial interface printers with the DDMS software and will not be responsible for any problems you may experience.

---

### Setting Up the Printer through Windows 2000

When you set up a printer, you must first add the printer through Windows 2000. Then, you must enter information for the printer to communicate with your DDMS software.

## Setting Up a New Ensite Pro System

To set up a printer:

- 1 Click the Start button, choose Settings, and then Printers.
- 2 Double click Add Printer.
- 3 When the Add Printer Wizard starts, follow the prompts on screen.
- 4 When you finish adding the printer, enable Xon/Xoff on your printer. You do this through the printer's own configuration utility. Refer to your printer's documentation for instructions.

### Configuring Your Printer for Ensite Pro

Configure your printer so that Ensite Pro can use it by following these steps:

- 1 From your server's desktop, double click the TBL Configuration icon.
- 2 When the Tbl Config window appears, click the Printer Definitions option to highlight it. The system displays all the printers you have set up on the right hand portion of the window, including the dummy printer, PØ. (This replaces B:.)
- 3 Right-click Printer Definitions, and choose Add New. The Printer Definition dialog box appears, as shown below.

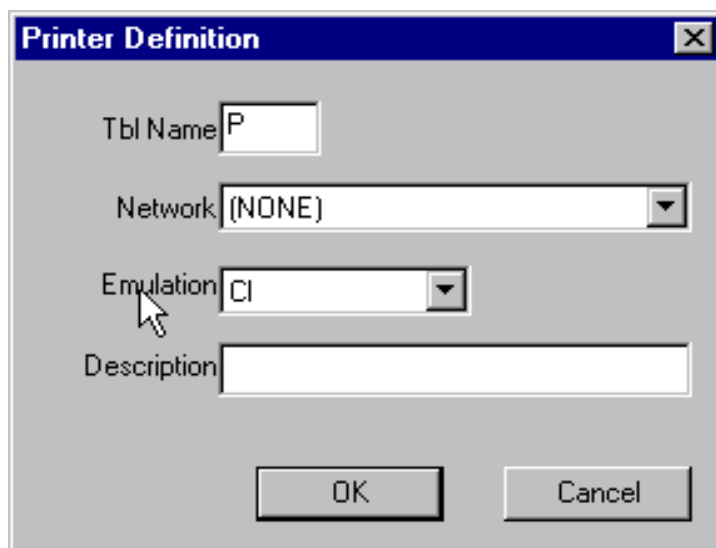

- 4 In the Tbl Name box, click the cursor behind the letter **P** and enter the logical number of the printer, 1, 2, or 3, for example. Press Tab.

Each printer must have a logical number. If you specify the same logical number for several printers, the system uses the first one available.

- 5 In the Network box, select the printer you are adding. (Both local and network printers that you set up under Windows 2000 appear on this list.)
- 6 In the Emulation box, set up Epson Emulation.
- 7 In the Description box, you can enter any text for your own reference that describes this printer. For example, you could enter Invoice Printer.

### Setting Up Dumb Terminals

If all DDMS users will be on networked PCs, and you do not have dumb terminals to set up, your system is now ready to use.

Setting up a dumb terminal requires two steps: connecting the terminal to your I/O pad, and configuring it for Ensite Pro.

### Connecting your Terminal to the I/O Pad

You need a special cable to connect a terminal to your I/O pad. If you do not already have a terminal cable, you have several options for obtaining it:

- Purchase a terminal cable from DDMS; call Sales at **800-366-3367**.
- Purchase a terminal cable from DDC; call **888-826-4747**.
- Have a local networking contractor make them for you.

If you purchase cables from DDMS or DDC, one end will be labeled CPU, and the other end will be labeled Terminal SPX .

Connect the CPU end of the cable to an open port on the I/O pad, and tighten the screws.

Connect the cable end with the Terminal SPX module to the terminal, as shown here:

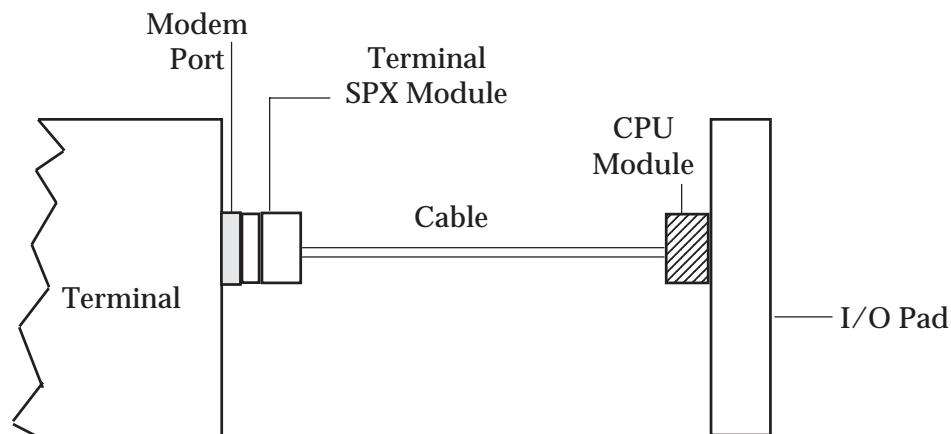

## Configuring Dumb Terminals for Ensite Pro

To set up dumb terminals on your system, follow these steps:

- 1 From your server's desktop, double click the TBL Configuration icon.
- 2 Right-click Terminal Definitions, and select Add New. The Terminal Definition window appears, as shown below.

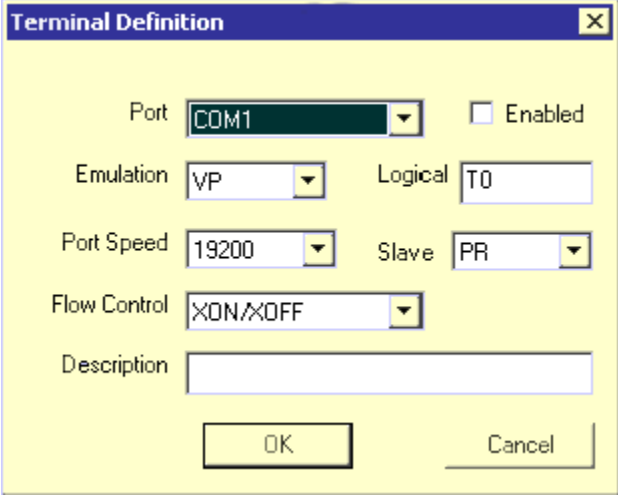

The screenshot shows a 'Terminal Definition' dialog box with the following settings:

- Port: COM1
- Emulation: VP
- Port Speed: 19200
- Flow Control: XON/XOFF
- Logical: T0
- Slave: PR
- Enabled:
- Description: (empty)

- 3 In the Port box, select the communication port that you connected this terminal to. Remember that port one on your I/O pad is COM3, port two on your I/O pad is COM4, and so forth.
- 4 Check the Enabled box.
- 5 In the Emulation box, select the appropriate emulation for your terminal.

DDMS recommends setting the terminal to an Adds emulation and specifying VP in the Emulation box, if your terminal supports this emulation.

If you're not sure how to set a terminal's emulation, check the terminal's documentation.

- 6 In the Logical box, enter a logical name for this terminal, T1, T2, or T3, for example.

---

**Note:** Logical names govern how a terminal behaves: which G/L location it defaults to , for example. All terminals that share a logical name also share the default settings for that name.

---

- 7 In the Port Speed box, select the port speed of the terminal. The speed you specify must match the port speed of your terminal. Check your terminal's documentation for information on finding and setting your terminal's speed.
- 8 In the Slave box, you can specify the emulation for a slave printer attached to this printer. However, only a few Citizen slip printers work as slaves under Windows.  
  
***DDMS does not recommend slave printers under Windows.*** Instead, set up each printer through the network, as described under **Setting Up Printers** earlier in this document.
- 9 In the Flow Control box, select XON/XOFF.
- 10 In the Description box, you can enter any text for your own reference that describes this terminal. For example, you could enter Point-of-Sale Terminal.
- 11 When you finish, click OK.
- 12 Close the TblConfig window.

# Chapter 2: Maintaining Your Ensite Pro System

This chapter describes the maintenance procedures that are unique to Ensite Pro systems.

## Preparing for Day-End

Day-end procedures are dedicated on Ensite Pro systems. No one else can use the system until you complete them.

You must restart your system before beginning your day-end procedures. This ensures that your data and your system's memory are clean before you begin. Follow these steps:

- 1 Press = at the Main Menu to log off. (Make sure all users are logged off.)
- 2 Make sure that all reports and batches are finished. To do this, go to TBL Server, and click on each user name in turn. If there is activity for that user, it will appear in the right-hand pane.
- 3 If you find activity for any user, wait until it's finished before beginning your dedicated procedure. The display for a particular user will not update itself while it's being displayed. To refresh the display, right-click the user's name, and select Refresh from the menu.
- 4 Close the TBL Server.
- 5 Click the Start button, and select Shut Down.
- 6 Click Restart, and press Enter.
- 7 When the system reboots, log in.
- 8 After the TBL Server starts, begin your normal day-end procedures. (For a complete list of day-end procedures, see the December issue of *Key Ops*.)

## Stopping (Killing) a Process

Occasionally, you may need to stop a process that a user has performed. For example, perhaps the modem is hung up, or the printer is not online. To stop a process:

- 1 From the Windows desktop, click the TBL Server icon in the taskbar at the bottom of the screen. The system displays the TBL Server window. (This window displays system users, and device information. It also displays any records or modems that may be locked on your system.)
- 2 Click the user whose process you want to stop. The system displays the user in the right hand portion of the screen along with the program the user is currently in.
- 3 To stop the process, right-click the user's name and select Kill.
- 4 At the Are You Sure You Want to Kill message, click OK.

## Backing Up DDMS Files

In the course of a business day, you are continually adding new files and changing existing ones. To maintain your valuable data, DDMS recommends that you back up your DDMS system files at least once a day, as part of your day-end procedures. Performing regular backups ensures that you will have an accurate and complete audit trail of your business activity. This lets you review or recover information at a later date without having to recreate it manually.

*Always reboot your system before backing up.*

To back up files on your Ensite Pro server:

- 1 Insert a backup tape into your drive.
- 2 *Make sure that you quit any programs that are currently running, including the TBL Server. The system will not back up any file that is open. To close the TBL Server:*
  - Click the TBL Server icon in the lower taskbar.
  - When the TBL Server window appears, choose File and select Exit.
  - At the Warning message, click OK.
- 3 Click Start, point to Programs, then Accessories, then System Tools, and select Backup.
- 4 Click the Backup tab.
- 5 Click the D:/DDMS folder to only backup DDMS files. (If you have DDMS files in any other folder, please select it, as well.)

## Setting Up a New Ensite Pro System

- 6 In the Backup Destination box, select the tape drive.
- 7 Click the Start Backup button.
- 8 In the Backup Job Information dialog box, click OK. The system backs up the files you selected.

### Restoring Files From Tape

Occasionally, you may need to restore volumes or files from a backup tape to your system's hard drive. When you restore files, remember that each DDMS file consists of three separate files: a .dbf, .cdx, and .key. To restore a specific file, you must restore all three DDMS files to your hard drive or you will only have partial data.

To restore system volumes or individual files, follow these steps:

- 1 Insert the tape into your drive.
- 2 *Make sure that you quit any programs that are currently running, including the TBL Server. The system cannot restore any file that is open. To close the TBL Server:*
  - Click the TBL Server icon in the lower task bar.
  - When the TBL Server window appears, choose File and select Exit.
  - At the Warning message, click OK.
- 3 Click **Start**, point to **Programs**, then **Accessories**, then **System Tools**, and select **Backup**.
- 4 When the Backup window appears, click the **Restore** tab.
- 5 Windows 2000 keeps a catalog of backups. The information you want to restore must have a catalog entry before you can restore it.

If the information on your tape has been cataloged, you'll see icons in the left pane.

If you see only the File icon, go to **Step 8**.

If the information on your tape has not been cataloged, you will either see the New Import Media dialog box, or an Import icon in the left pane.

If you see the New Import Media dialog box, go to **Step 6**.

If you see the Import icon, go to **Step 7**.

## Setting Up a New Ensite Pro System

- 6 If you see the New Import Media dialog box, catalog the information on your tape by selecting **Allocate this media to Backup now**.

Click OK, and go to **Step 8**.

- 7 If you see the Import icon, click the plus sign (+) next to it to display the entries.

Right-click the entry you want to restore from, and catalog it by selecting the **Add to Backup Media** option, as shown here.

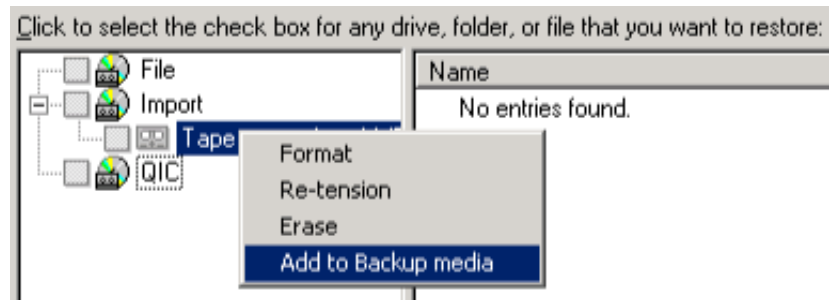

- 8 Click the plus sign (+) by the QIC icon to open it.
- 9 The cataloged entries on your tape appear in the right pane. Double-click the appropriate entry. Your system will read the tape, and display the drives that you backed up.
- 10 You can restore an entire volume by selecting the corresponding folder. You can also choose to restore individual files within a folder.

Double-click the drive that contains the folders or files you want to restore.

If there is more than one entry for the correct drive, as shown below, you need to check each of them for the folder or files you want to restore.

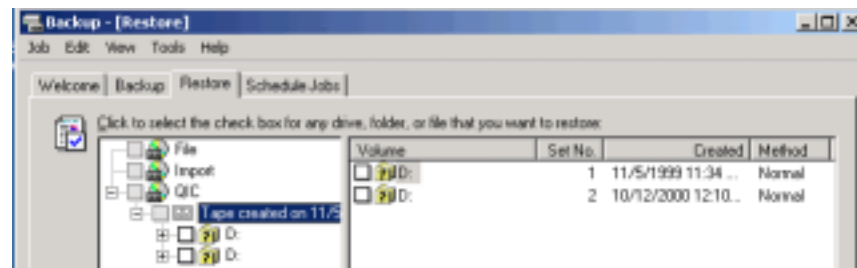

## Setting Up a New Ensite Pro System

- 11 Once you find the correct drive, open the DDMS folder by clicking it. A folder for each volume serial included on this backup appears in the left pane, as shown below.

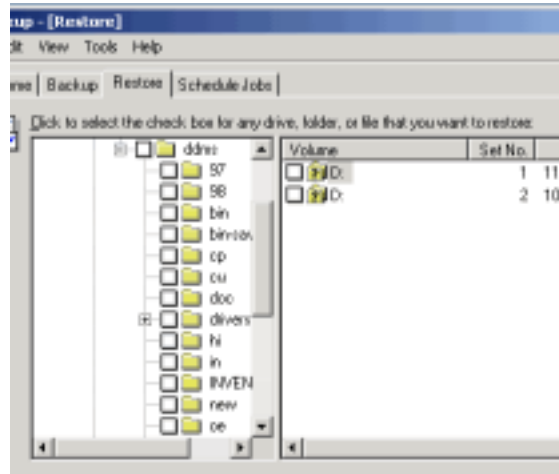

- 12 To restore an entire volume, click the corresponding folder. A blue check mark indicates that you selected an entire folder.

To restore individual files, double-click the appropriate folder, and then select the files. *If you specify specific files, be sure to select all three files: a .dbf, .cdx, and .key. If you do not select all three, you will not restore all the data.*

In the figure below, all three of the circled files must be restored if you want to restore the C-MASTER file. Note that the files you select have blue check marks, and the folder containing these files has a grey check mark. The grey check mark indicates that some of the files it contains have been selected, but not all.

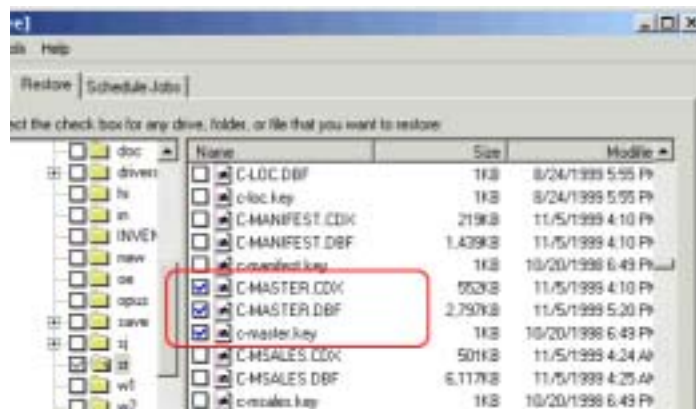

- 13 After selecting all the files or volumes you want to restore, select the appropriate option in the Restore Files To box:
- **Original location:** Restores files to the folders they were backed up from, and may overwrite existing files with the same name.
  - **Alternate location:** Lets you specify a different location for your files. This option creates the necessary folders within the folder you specify. If you're restoring the IN folder, for example, and you select an alternate location of C:, the system will create an IN folder on C:.
- 14 The type of restoration you're doing is displayed to the right of the Restore Files To box. The option displayed in the figure below always overwrites the existing files with those from your backup tape:

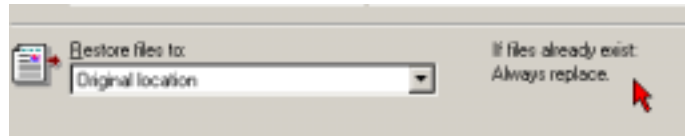

You have three options to choose from:

- Do not replace any existing files
- Replace files only if the existing file is older
- Always replace existing files.

If the displayed option is not what you need, go to the **Tools** menu, and select **Options**. Click the **Restore** tab, select the appropriate option, and click **OK**.

- 15 Click the **Start Restore** button.

## Shutting Down the System

You should not turn off your Ensite Pro server by pressing the power button or by removing power until you first perform a shutdown procedure. This procedure prevents you from losing valuable data and stops all processes that may currently be using the system's resources. To safely shut down the system, follow these steps:

- 1 From the server's desktop, click Start, and choose Shut Down.
- 2 In the Shut Down Windows dialog box, select Shut Down.
- 3 Click OK.
- 4 After the system has completely shutting down, you can safely turn off the system. (Many systems turn the power off automatically.)

## Appendix: Dedicated Functions

Dedicated functions are procedures that can only be performed when no one else is using the system.

***Performing a dedicated function while other people are using the system can cause loss of information and corruption of files.***

Many of these functions are necessary for periodic maintenance of the system. You should perform these procedures at the end of the business day to prevent interrupting daily activities.

### Performing a Dedicated Function

To perform a dedicated function, follow these steps (unless otherwise instructed by DDMS):

- 1 Make sure that all terminals are turned off or are in the Master Menu.
- 2 Make sure that all reports and batches are finished. To do this, go to TBL Server, and click on each user name in turn. If there is activity for that user, it will appear in the right-hand pane.
- 3 If you find activity for any user, wait until it's finished before beginning your dedicated procedure. The display for a particular user will not update itself while it's being displayed. To refresh the display, right-click the user's name, and select Refresh from the menu.
- 4 Perform your dedicated function.
- 5 Check the TBL Server again to make sure the dedicated function is complete.
- 6 Reboot the system before allowing other users to resume work. To do this, follow these steps:
  - a From the server's desktop, click Start, and choose Shut Down.
  - b In the Shut Down Windows dialog box, select Restart.
  - c Click OK.

---

*Another way to refresh the display is to click another user's name, then click the first user's name again.*

---

## Dedicated Functions

Each dedicated function is listed below.

### Functions Using Windows Software

Read Tape

### Period Ending Procedures

#### Day-End

Daily procedure (MA)

A/R batch release (OA)

A/P batch release (QA)

P/O purge (SP)

Exceptions report (TI)

#### Month-End

Customer month-end (AHM)

Vendor month-end (CM)

Inventory month-end (EM)

Salesperson month-end (HYM)

#### Year-End

Customer year-end (AHY)

Vendor year-end (CY)

Inventory year-end (EY)

Salesperson year-end (HYY)

Clear inventory hits (+A)

Clear customer hits (+E)

### Parameters Screens

Changing the next number field in any parameter screen.

#### Purging

Accounts receivable (OD)

Accounts payable (QC)

P/O purge (SP)

Purchase orders (SP)

## Setting Up a New Ensite Pro System

### Reindexing Files

- Customer (AHR)
- Inventory (EHR)
- Pick (order entry) (TE)
- Salesperson (HYR)
- Personnel (HNR)
- Vendor (CR)
- Item Alias (ESR)
- Serial (EZP/EZG)

### Releasing Batches

- Accounts receivable (OA)
- Accounts payable (QA)
- General ledger (WA)

### Special Screen Functions, if modifying data

- Customer (+A)
- Accounts receivable (+B)
- Vendor (+C)
- Accounts payable (+D)
- General ledger (+J)
- Sales journal history (+U)
- Inventory (+E)
- Reset inventory (+P)

### Utilities (functions in the (Z) screen)

- Execute program (B4)
- Execute Proc file (B6)
- Copy single file (C2)
- Sort a file (C4)
- Merge files (C5)
- Delete single file (F4)
- Delete data records (F6)
- Rename a file (F7)